



LAP
ELECTRICAL
LIMITED

TITAN

LED LIGHTBAR RANGE



TITAN

LED LIGHTBAR RANGE

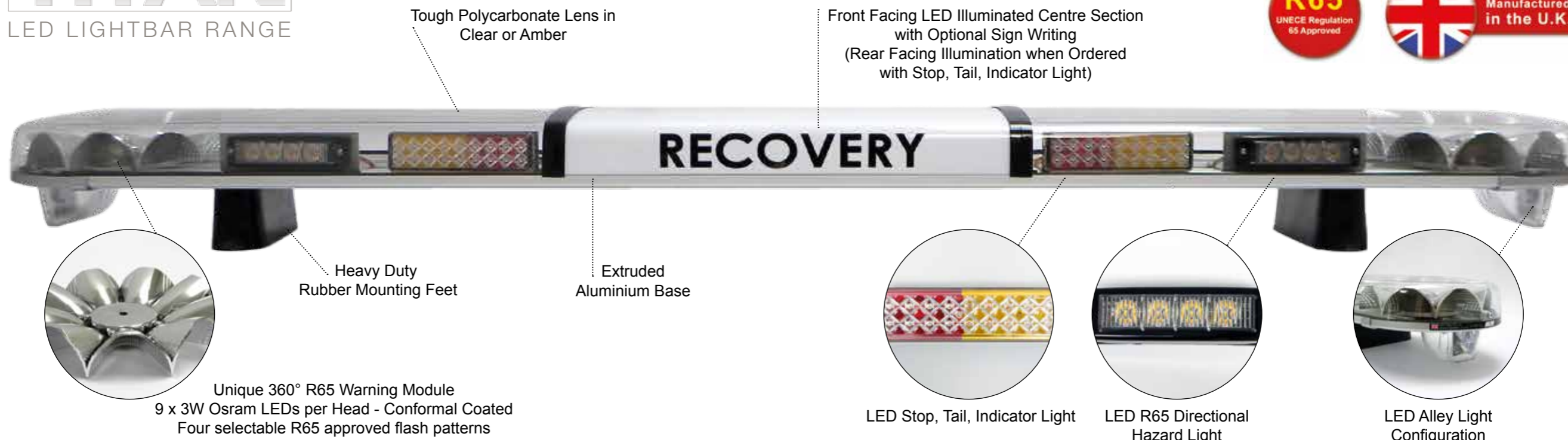

The Next Generation of LED Lightbars

Combining the latest LED technology with unique optics, the new TITAN lightbar range provides a brilliant 360° of visual warning that is ECE R65 approved.

Designed and manufactured in the UK, the TITAN lightbar is built to your exact requirements, offering a variety of flexible options to suit multiple vehicle applications including hazard lights, stop/tail/indicators, alley lights and centre illumination with optional sign writing.

FEATURES:

- Dual Voltage (12/24V)
- 2ft (0.6m), 2½ft (0.76m), 3ft (0.9m), 4ft (1.2m), 5ft (1.5m) & 6ft (1.8m) models available
- Four R65 approved flash patterns (single, double, triple, quad flash)
- Optional airport flash pattern (upon request)
- Meets ECE R65 & EMC regulations (ECE R10)
- 360° high performance optics for improved safety
- Amber or clear polycarbonate lenses
- Extruded aluminium base
- Fully encapsulated electronic control module
- Long life LED technology
- Opal, clear or amber centre sections available
- 4 bolt mounting fix / High rise feet option
- Extreme temperature reliability -30° to +50°
- 3 year warranty
- 2ft Magnetic models available
- 2.5 metre multi-core cable

For more information visit our website www.lapelec.co.uk to view the new TITAN lightbar video



Special request lightbar service
As we manufacture all our Titan lightbars at our UK production facility we can accommodate any specification that you require. Simply contact our customer services team and we will be happy to assist.

	Current Consumption 12V	Current Consumption 24V
R65 LED Module (x1)	2 amp	1 amp
Centre Illumination (x1)	0.4 amp	0.2 amp
Alley Light (x1)	0.3 amp	0.15 amp
Hazard Light (x1)	0.3 amp	0.15 amp
Stop, Tail, Indicator (x1)	0.6 amp	0.3 amp

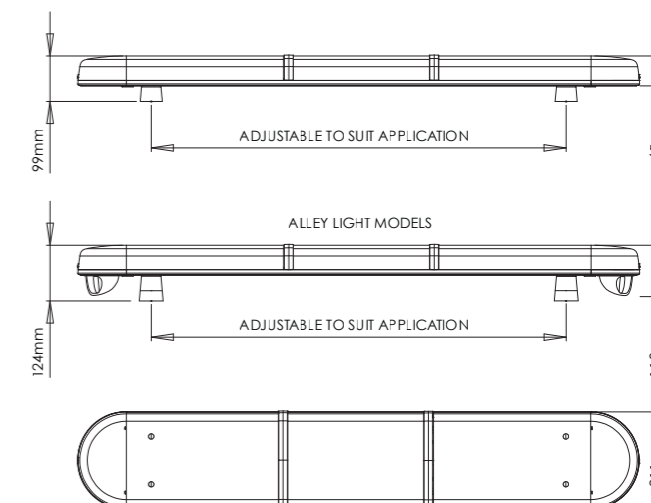

TITAN Lightbar Specifications



These lightbar drawings are for illustration purposes only

Reflector Module 	Stop, Tail, Indicator Light STI	Hazard Light HAZ	Alley Light A	Magnetic 
---	---	----------------------------	-------------------------	---





Lightbar Length - 2ft (610mm)

 LB242AC	 LB242AC/MAG	 LB242WA	 LB242WA/MAG
--	--	--	--



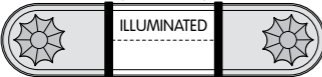
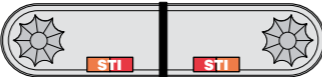





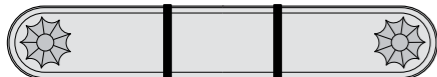
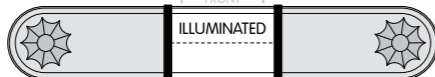
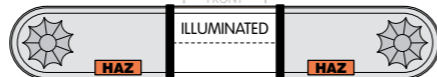

Lightbar Length - 2½ft (762mm)

 LB302AC	 LB302WA
--	--

Lightbar Length - 3ft (915mm)

 LB362AC	 LB362AC/I	 LB362AC/S
 LB362WA	 LB362WA/I	 LB362WA/S

Lightbar Length - 4ft (1220mm)

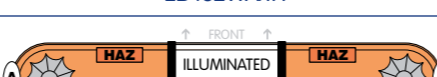
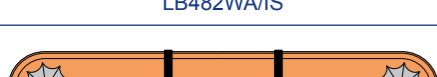
 LB482AC	 LB482AC/I	 LB482AC/IH
 LB482AC/IS	 LB482AC/ISHA	 LB482AC/IHHA
 LB482AC/S		
 LB482WA	 LB482WA/I	 LB482WA/IH
 LB482WA/IS	 LB482WA/ISHA	 LB482WA/IHHA
 LB482WA/S		







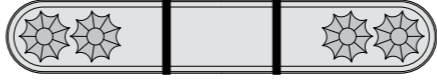
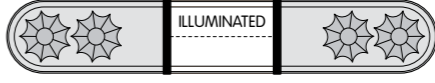
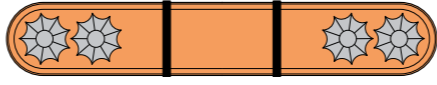
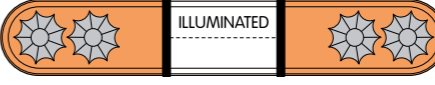



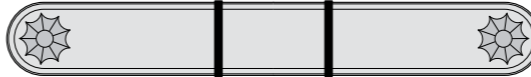
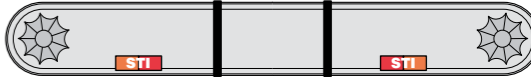
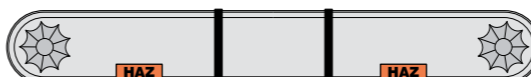
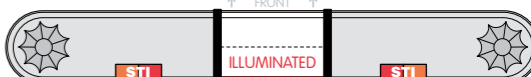

These lightbar drawings are for illustration purposes only

Reflector Module 	Stop, Tail, Indicator Light STI	Hazard Light HAZ	Alley Light A	Magnetic 
---	---	----------------------------	-------------------------	---

Lightbar Length - 4ft (1220mm) continued...

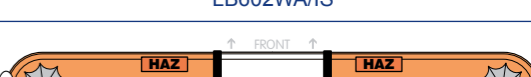
 LB484AC	 LB484AC/I
 LB484WA	 LB484WA/I



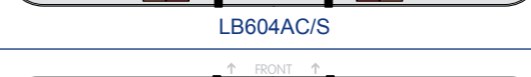
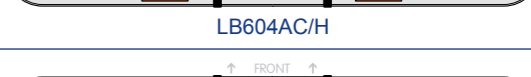

Lightbar Length - 5ft (1524mm)

 LB602AC	 LB602AC/S
 LB602AC/H	 LB602AC/IS
 LB602AC/ISHA	 LB602AC/ISHHA
 LB602WA	 LB602WA/S
 LB602WA/H	 LB602WA/IS
 LB602WA/ISHA	 LB602WA/ISHHA
 LB604AC	 LB604AC/I
 LB604AC/S	 LB604AC/H
 LB604AC/IS	 LB604AC/ISHA



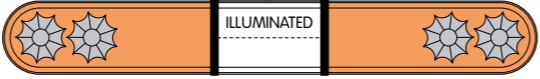



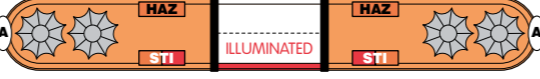



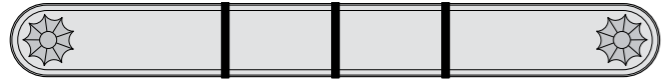
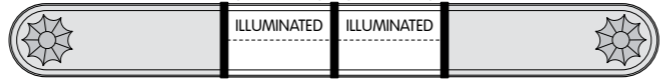

These lightbar drawings are for illustration purposes only

Reflector Module 	Stop, Tail, Indicator Light STI	Hazard Light HAZ	Alley Light A	Magnetic 
---	---	----------------------------	-------------------------	---

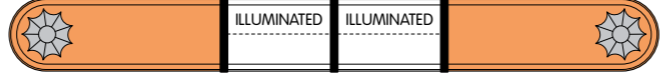
Lightbar Length - 5ft (1524mm) *continued...*

 LB604WA	 LB604WA/I
 LB604WA/S	 LB604WA/H
 LB604WA/IS	 LB604WA/ISHA









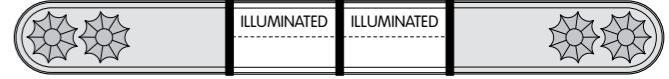

Lightbar Length - 6ft (1828mm)

 LB722AC	 LB722AC/I
 LB722AC/S	 LB722AC/H
 LB722AC/IS	 LB722AC/ISHA
 LB722AC/ISHHA	
 LB722WA	 LB722WA/I
 LB722WA/S	 LB722WA/H
 LB722WA/IS	 LB722WA/ISHA
 LB722WA/ISHHA	

These lightbar drawings are for illustration purposes only

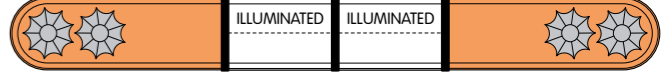
Reflector Module 	Stop, Tail, Indicator Light STI	Hazard Light HAZ	Alley Light A	Magnetic 
---	---	----------------------------	-------------------------	---

Lightbar Length - 6ft (1828mm) *continued...*

 LB724AC	 LB724AC/I
 LB724AC/S	 LB724AC/H
 LB724AC/IS	 LB724AC/ISHA
 LB724WA	 LB724WA/I
 LB724WA/S	 LB724WA/H
 LB724WA/IS	 LB724WA/ISHA



What is ECE Regulation 65 ?



This regulation applies to vehicle warning lighting such as lightbars and beacons and ensures that a range of key measurements are met in terms of light output and environmental performance. This test is carried out under laboratory conditions, once approved products are issued with a certificate and it is a requirement for the "E" mark to be visibly displayed on the product.

The TITAN lightbar range is certified to the latest ECE Regulation 65 standard. Recent changes now require that any pre-set flash patterns installed in the electronics must all meet the regulation, consequently all four flash patterns in the Titan meet the new directive.

In Europe all working vehicles must be fitted with Regulation 65 approved products, however in the UK this is not mandatory. Many UK fleet operators or insurance companies will follow the guidelines set out in the Traffic Signs Manual under Chapter 8 (section 5.3) which recommends the use of Regulation 65 approved products.



LAP ELECTRICAL LIMITED
Old Walsall Road, Great Barr, Birmingham B42 1EA. United Kingdom.

Contact the LAP Sales Team
Telephone: +44 (0) 121 386 7377 or +44 (0) 121 386 7379
Facsimile: +44 (0) 121 681 1149
Email: enquiries@lapelec.co.uk
Website: www.lapelec.co.uk